

USEF Dressage Seat Equitation Individual Workouts

Easy and Short No. 1:

Canter on diagonal, change leads through trot on centerline.

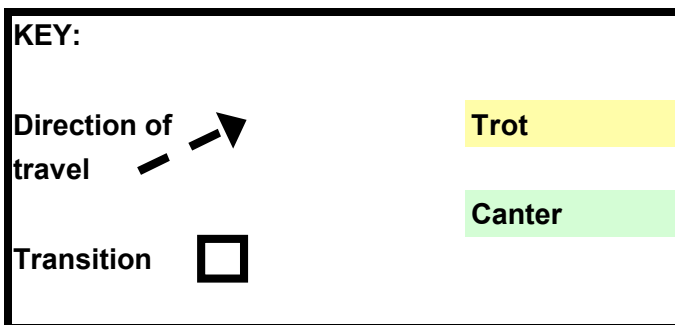
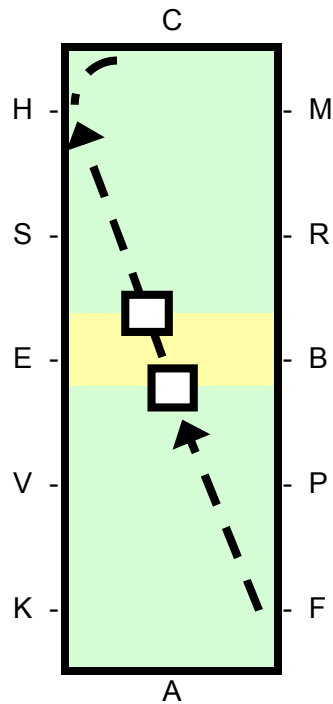

USEF Dressage Seat Equitation Individual Workouts

Easy and Short No. 2:

Working trot on centerline, at X figure 8 with 10 meter circles

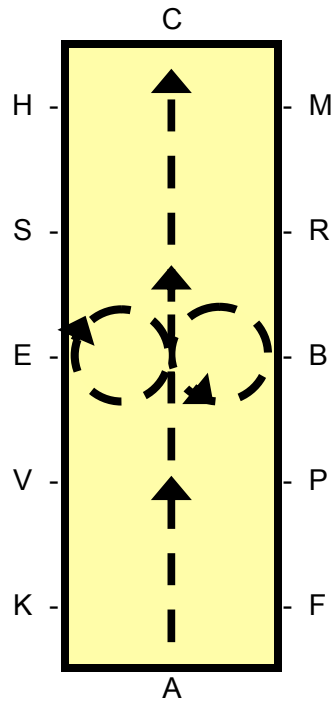

USEF Dressage Seat Equitation Individual Workouts

Easy and Short No. 3:

On centerline at working trot, pick up lead directed by judge at X

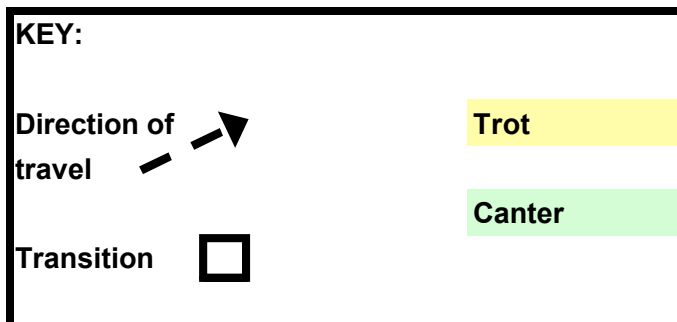
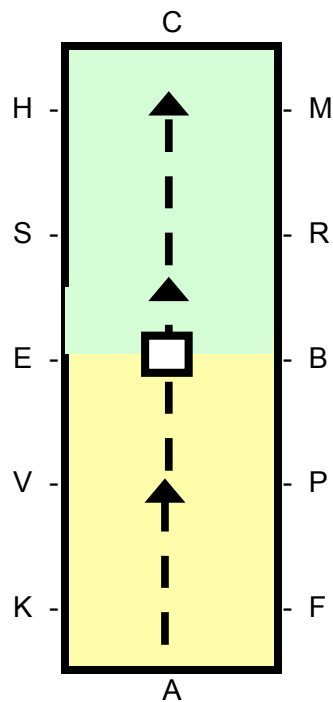

USEF Dressage Seat Equitation Individual Workouts

Easy and Short No. 4:

Three loop serpentine at trot, width of arena

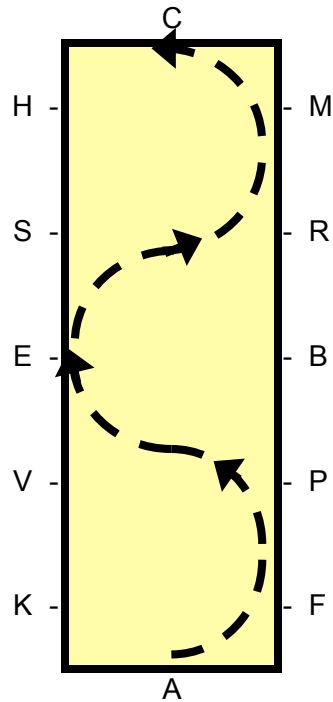

USEF Dressage Seat Equitation Individual Workouts

Easy and Short No. 5:

Canter 3 loop serpentine, width of arena, changing leads through trot on centerline

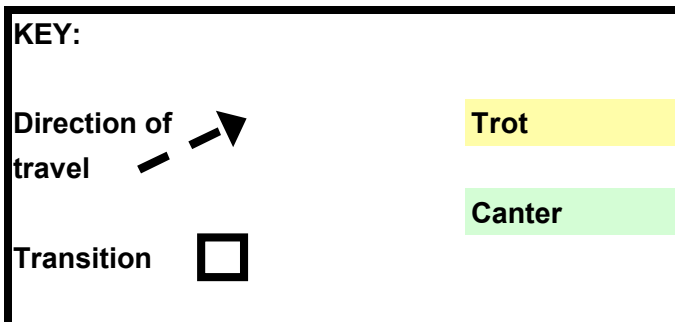
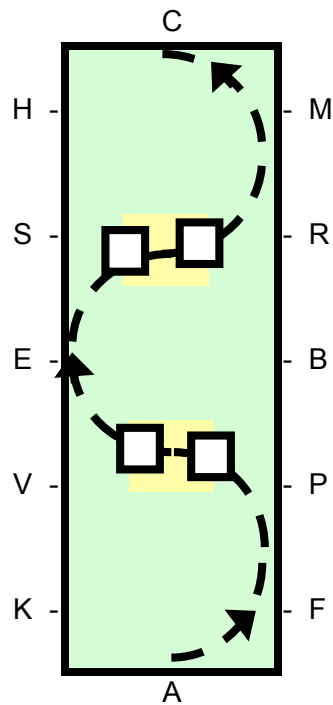

USEF Dressage Seat Equitation Individual Workouts

Medium and Short No. 1:

At canter from A, turn down centerline. Change of lead through trot twice, the first between D & L, and the second between I & G. Track left (or right) at C and make transition to walk through trot on long side.

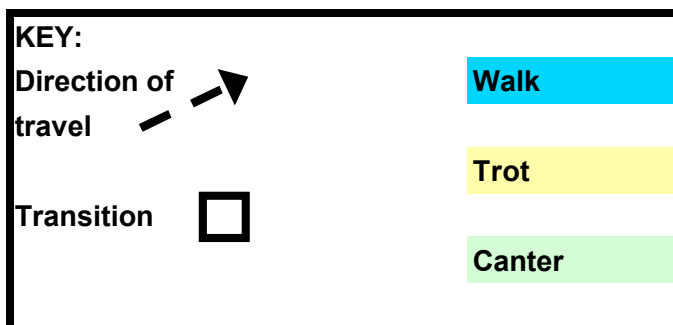
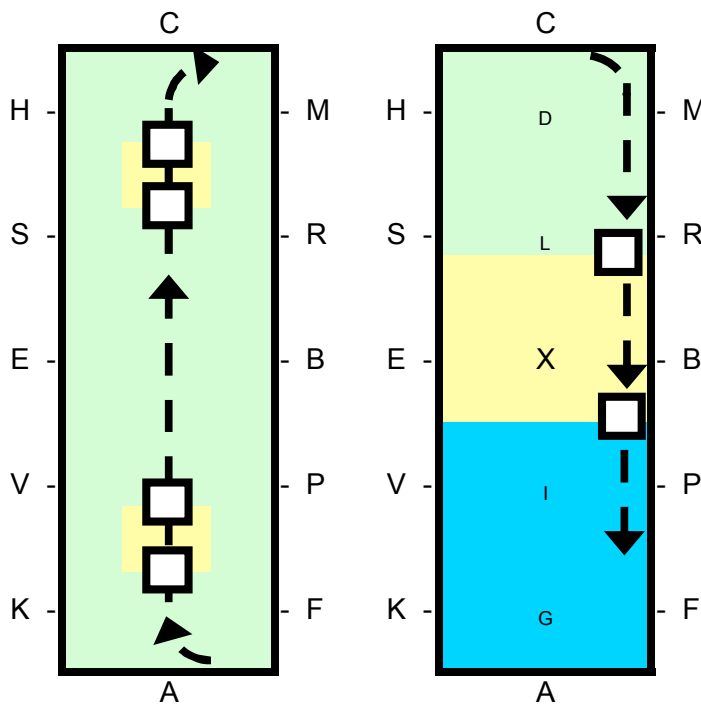

USEF Dressage Seat Equitation Individual Workouts

Medium and Short No. 2:

Leg yield at working trot, changing from leg yield right to leg yield left, or vice versa once (specify letters for start and finish of each leg yield)

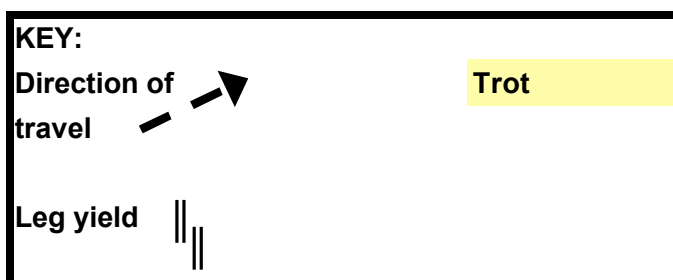
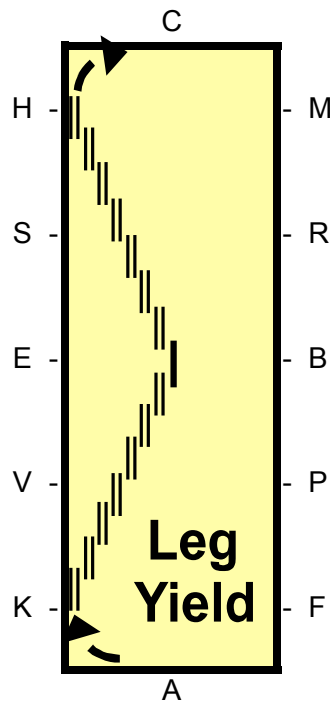

USEF Dressage Seat Equitation Individual Workouts

Medium and Short No. 3:

Working canter on long side, lengthening the stride twice on that side for about five strides each time, shortening for a few strides at E or B

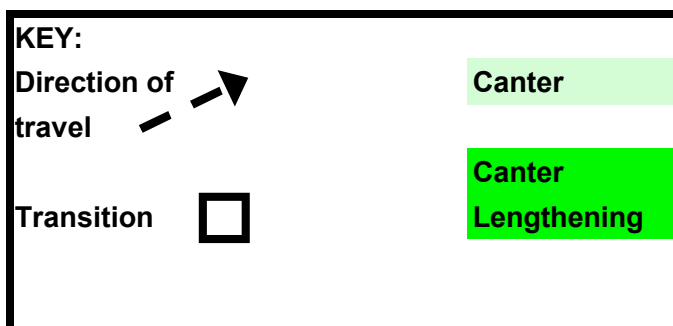
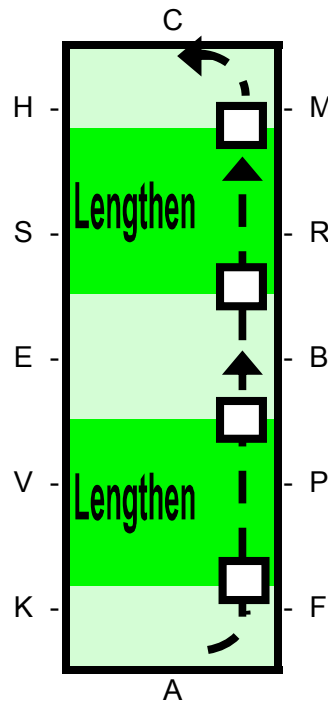

USEF Dressage Seat Equitation Individual Workouts

Medium and Short No. 4:

Working trot to the right. At the beginning of the long side, leg yield right to X 10 meter circle right at x followed by 10 meter circle left, followed by leg yield left to the corner.

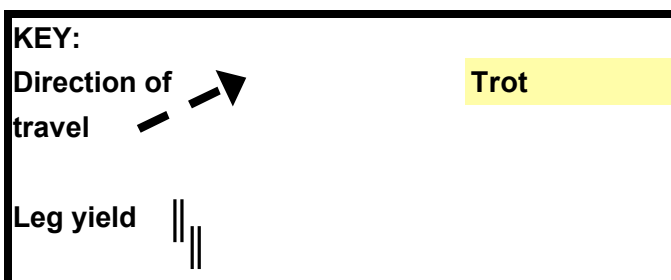
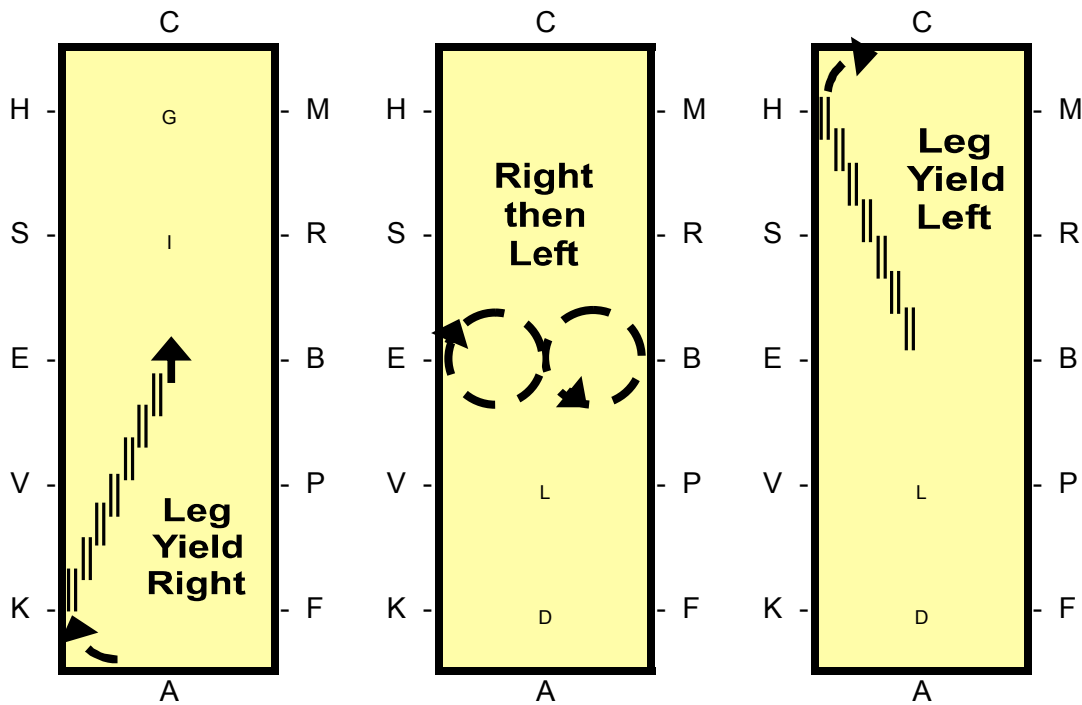

USEF Dressage Seat Equitation Individual Workouts

Medium and Short No. 5:

Working trot down centerline. Leg yield about 8 strides to the left, followed by a leg yield to the right back to the centerline. Halt before end of centerline.

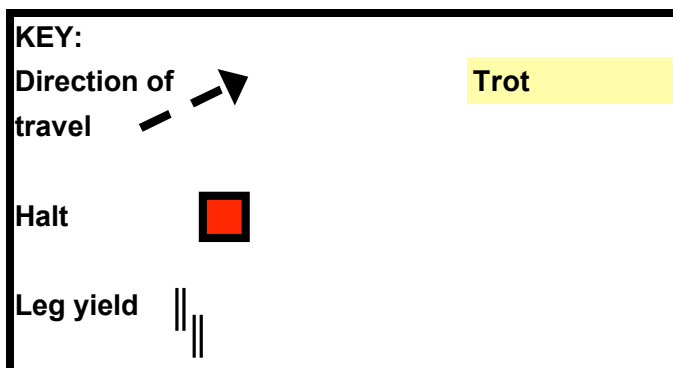
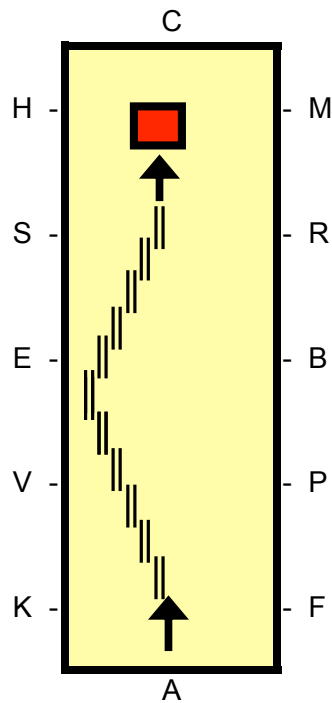

USEF Dressage Seat Equitation Individual Workouts

Medium - Suitable for Semi-Finals and Finals No. 1:

- Working trot tracking right
- C Turn down centerline
- X Working canter, left lead
- A Turn left
- F Lengthen strides in canter
- R Working canter
- E Working trot
- F Leg yield left to X
- I Halt, proceed at medium walk

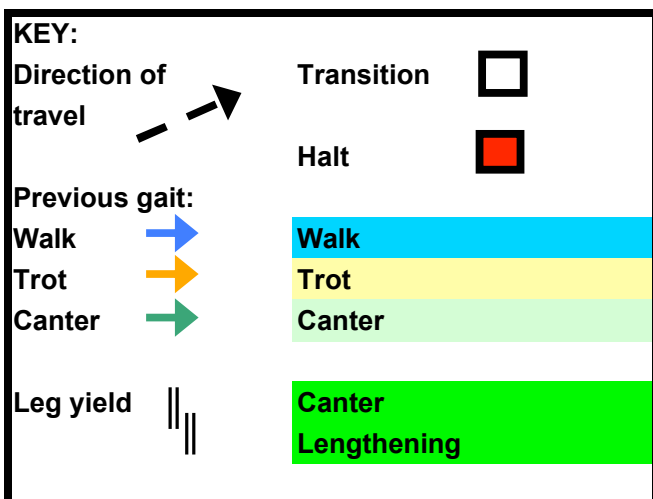
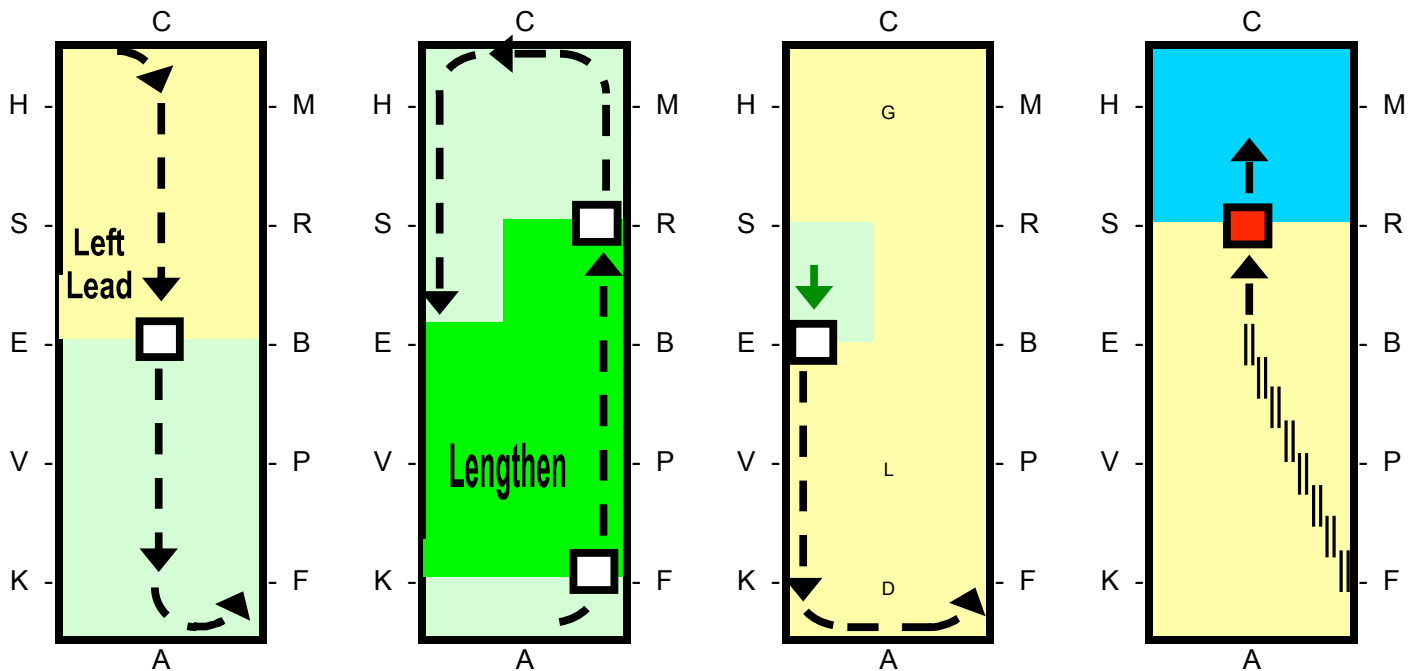

USEF Dressage Seat Equitation Individual Workouts

Medium - Suitable for Semi-Finals and Finals No. 2:

- R tracking left at free walk
- M Medium walk
- C Working trot
- H Leg yield left to X
- X to L on centerline
- L Working canter, right lead
- A Track right
- K Lengthen strides in canter
- E Working canter
- H Working trot.
- C Halt.

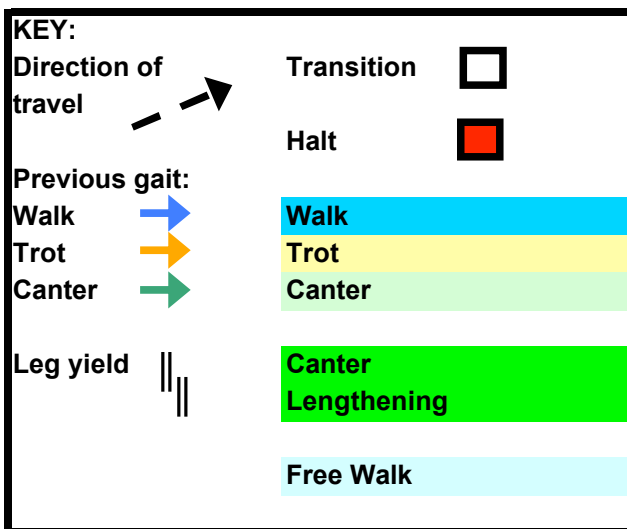
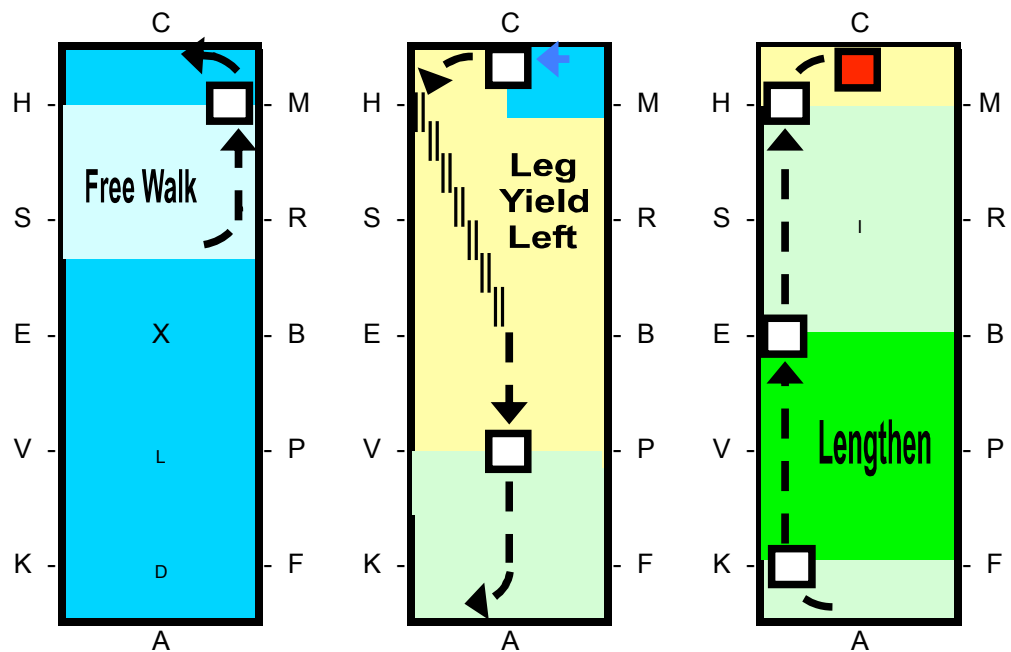

USEF Dressage Seat Equitation Individual Workouts

Medium - Suitable for Semi-Finals and Finals No. 3:

R Free walk tracking left

C Medium walk

H Working trot

E Working canter, left lead

A to C Three loop serpentine changing leads through trot across centerline

C Working trot

S to L Leg yield left to centerline

D Halt, proceed free walk

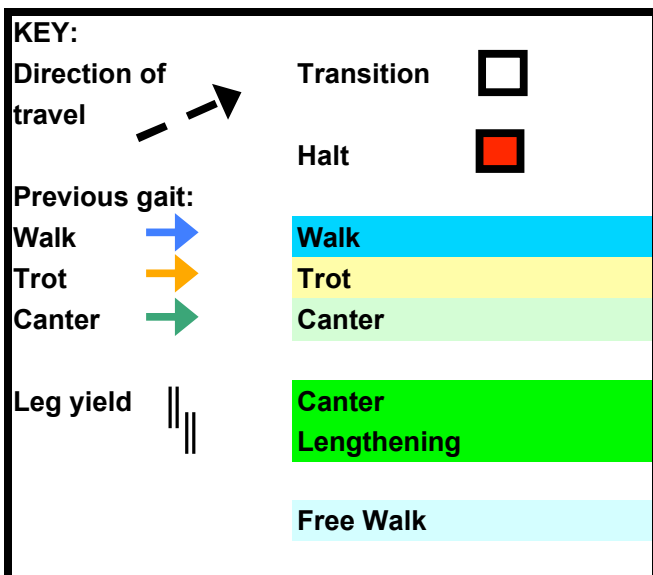
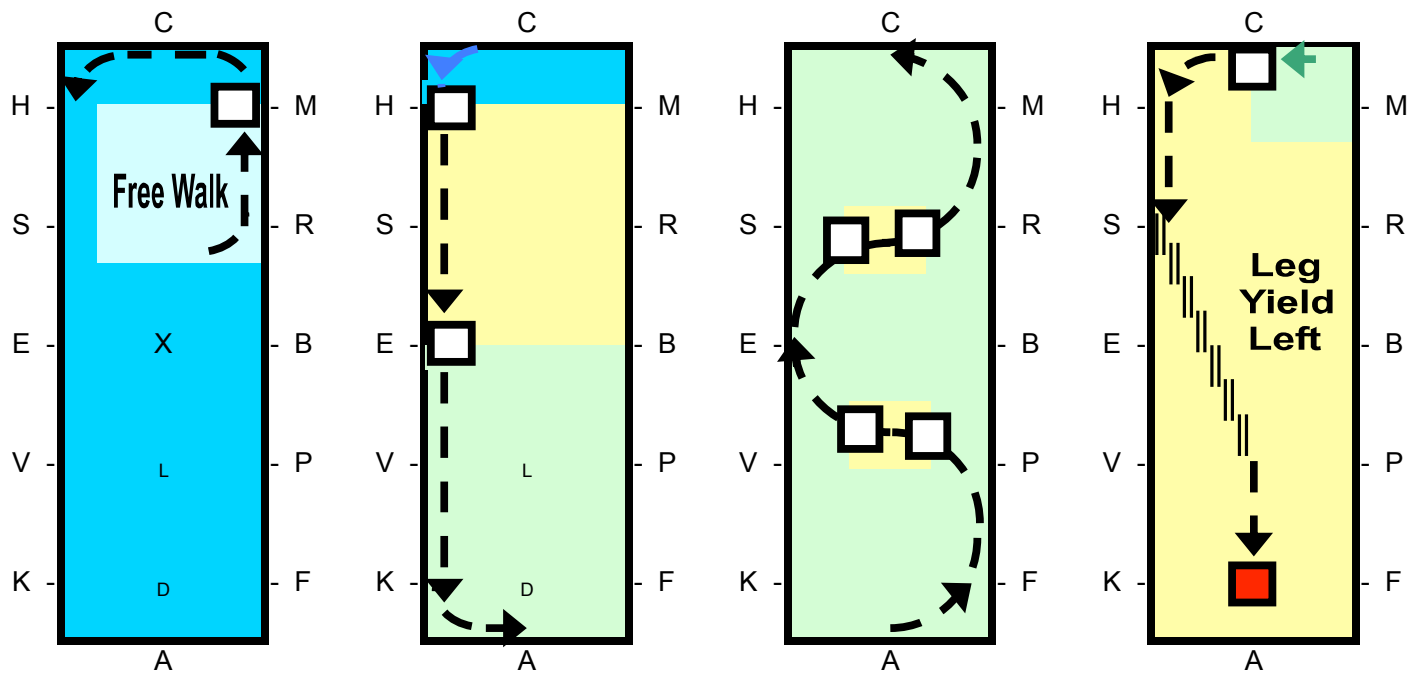

USEF Dressage Seat Equitation Individual Workouts

Medium - Suitable for Semi-Finals and Finals No. 4:

- C On centerline at working trot
- G Leg yield left to B
- B Working canter, right lead
- F Working trot
- A Down centerline
- D leg yield right to B
- B Working canter, left lead
- M Working trot
- C Halt, proceed medium walk

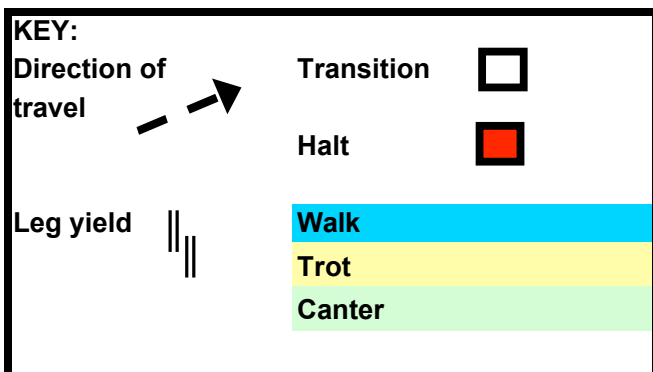
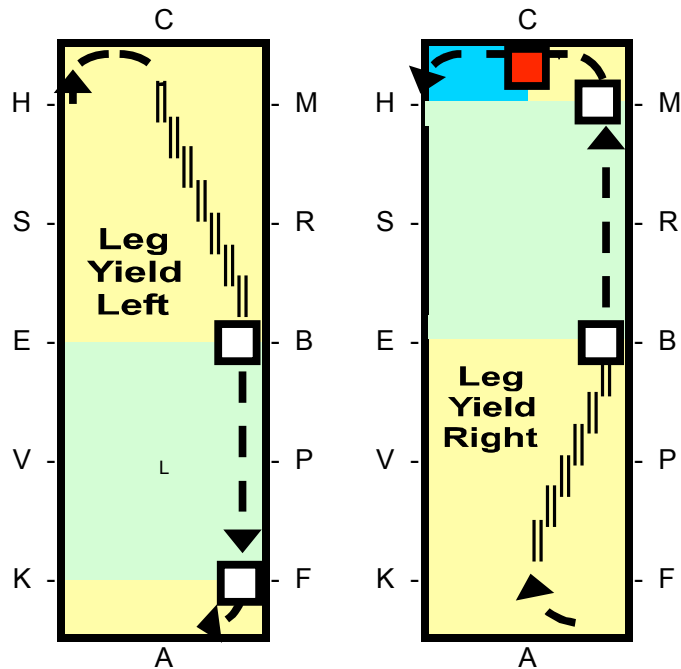

USEF Dressage Seat Equitation Individual Workouts

Medium - Suitable for Semi-Finals and Finals No. 5:

C Medium walk tracking right

M Working trot

B 20 m circle right

Crossing centerline for the first time, working canter right lead

Crossing centerline for the second time, working trot

B Change direction through the circle (two ½ circles)

E Straight ahead

V Halt three seconds, proceed working trot

A Medium walk.

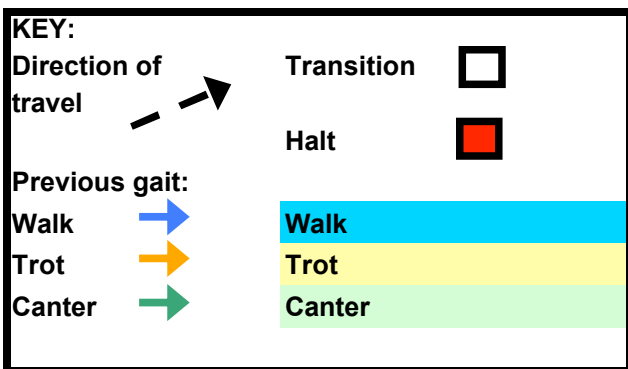
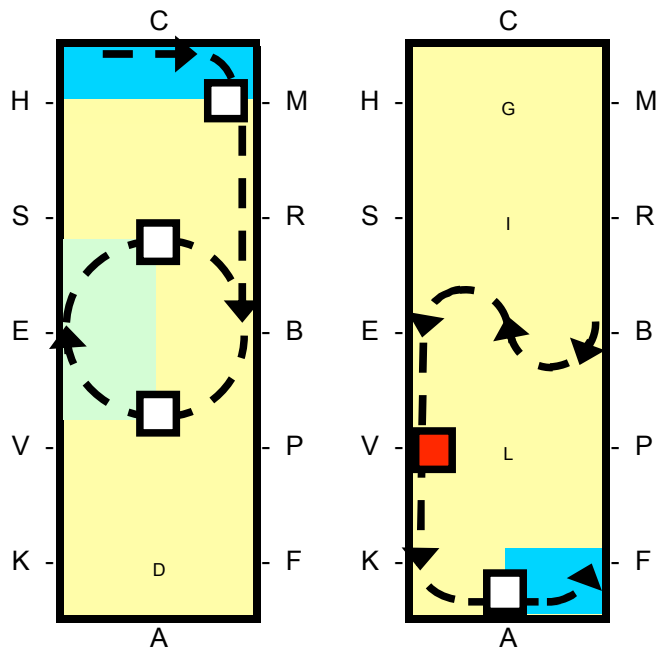

USEF Dressage Seat Equitation Individual Workouts

Difficult - Suitable for Semi-Finals and Finals No. 6:

C Track right at working trot

R Leg yield right to quarterline followed by leg yield left to P

A Working canter, right lead

KXM on diagonal, three changes of lead through the trot

C Working trot

S Halt, proceed at medium walk

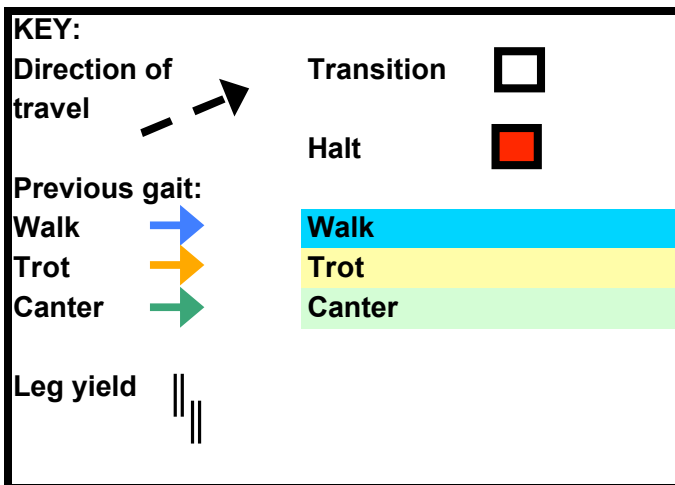
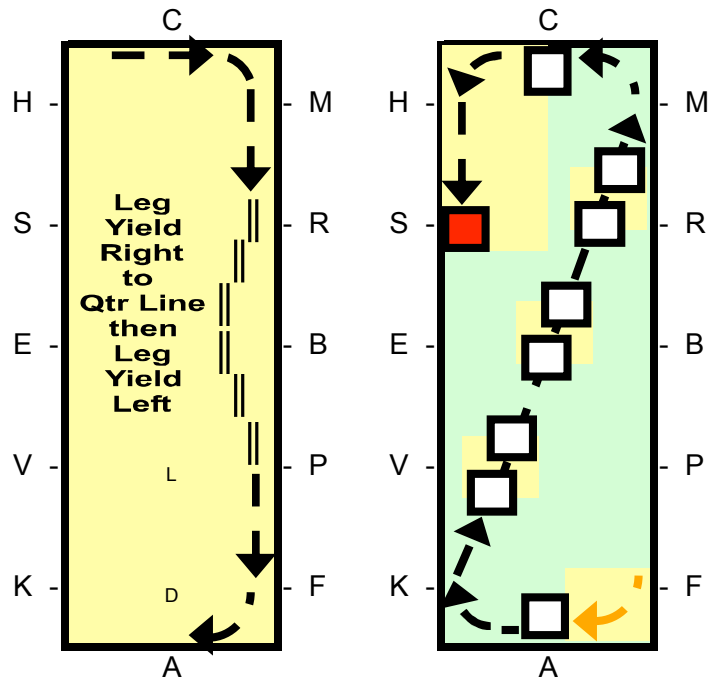

USEF Dressage Seat Equitation Individual Workouts

Difficult - Suitable for Semi-Finals and Finals No. 7:

R Free walk tracking left

M Medium walk

C Working trot

S two to three steps of walk and return to working trot

V two to three steps of walk and return to working trot

A Working canter, left lead

F to E Short diagonal, change lead though trot on crossing centerline

S to R half circle 20 M, lengthen strides in canter

R Working canter

B Working trot

P Half circle 10 M to centerline

X Halt, proceed medium walk.

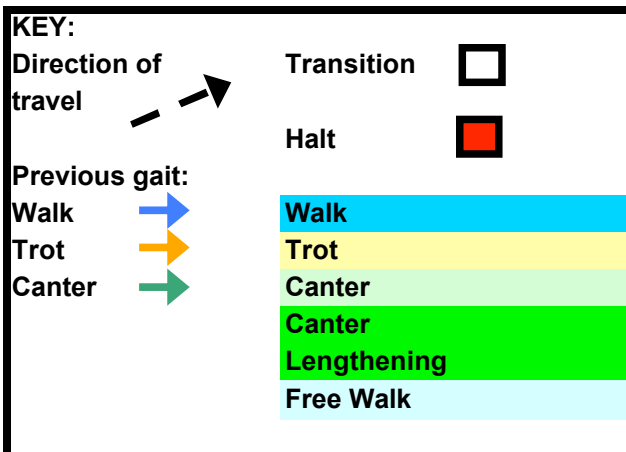
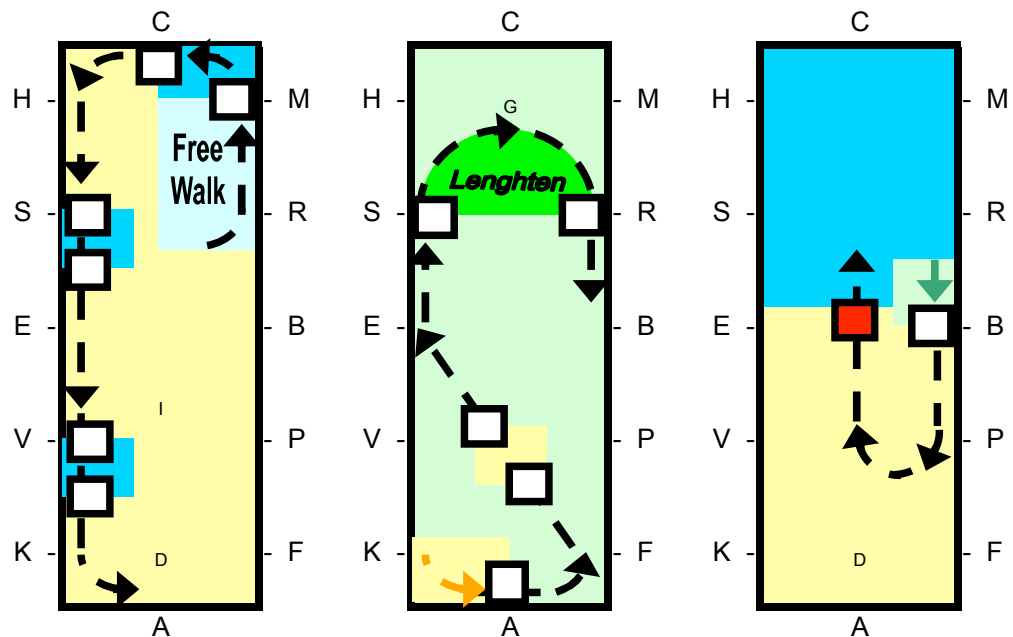

USEF Dressage Seat Equitation Individual Workouts

Difficult - Suitable for Semi-Finals and Finals No. 8:

- C Medium walk tracking right
- M Working trot
- R 1/2 circle right to l
- l 1/2 circle left to S
- E Working canter left lead
- A Down centerline
- D to E Working canter
- E to H Counter canter
- H Working trot
- C Halt, proceed medium walk.

